

CONNECTOR, IN-LINE

Part No.	ME 560C9W
Description:	60 Amp 3 Y 120/208Vac 4 Pole, 5 Wire Connector
Construction:	Watertight IEC IP 67
Approvals:	UL Listed Standards 1682; 1686 CSA Certification to Spec. C22.2 No. 182.1 IEC 60309-1; IEC 60309-2

IEC COLOR CODE: Blue

GROUND SOCKET: 9 Hour Position Mates with Male in 3 Hour Position.

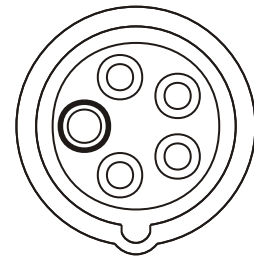
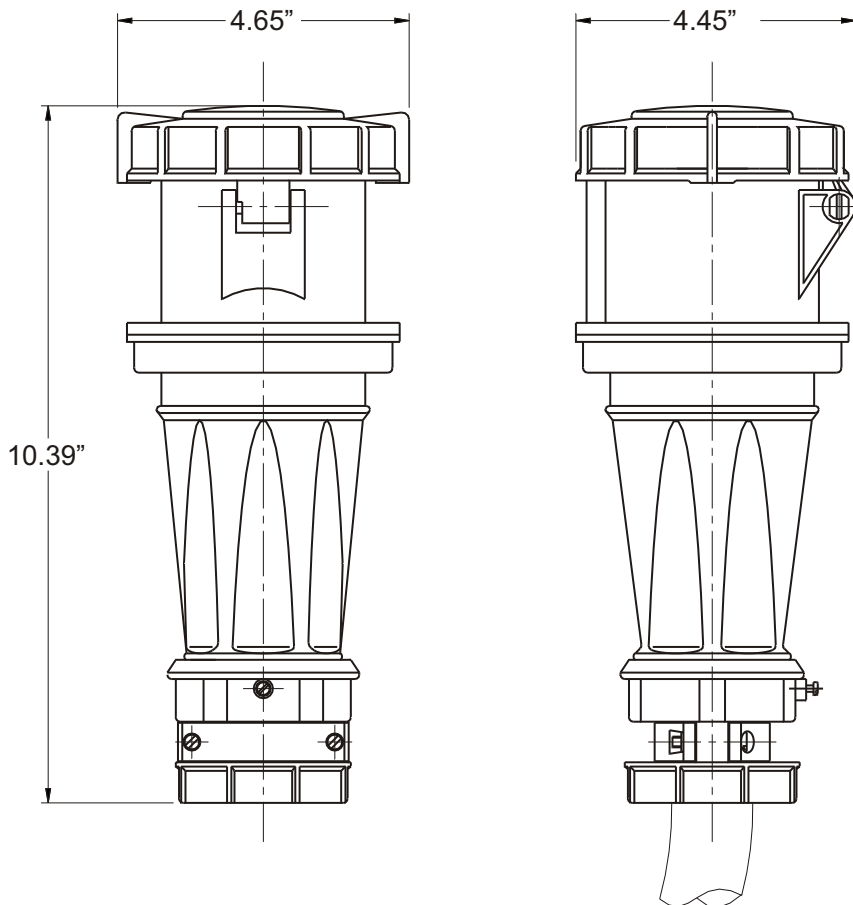

Front View of Connector

Wire Range: #4 - #8 AWG
Cord Range: .57" - 1.42"
Threaded Cable Entry: 1 1/2" NPT

Drawing Not to Scale